

# Reliable®

## Model KFR-CCS Combustible Concealed Space Sprinkler

K-factor 5.6 (80); SIN RA4454  
cULus Listed

### Features

- cULus Listed for areas of coverage up to 256 square feet
- Fast response 212°F (100°C) fusible link operating element
- Draft curtains not required for wood truss construction

### Product Description

The Reliable Model KFR-CCS Combustible Concealed Space Sprinkler is an upright, special sprinkler designed to provide protection of specific light hazard combustible and noncombustible concealed spaces requiring sprinkler protection.

The Model KFR-CCS Sprinkler utilizes a fast response solder-link fusible element that has demonstrated response times in laboratory tests which are five to ten times faster than standard response sprinklers. This feature enables the sprinkler to apply water to a fire much faster than standard response sprinklers of the same temperature rating.

### Application

The Model KFR-CCS sprinkler is specifically listed for the protection of horizontal combustible concealed spaces up to 36" deep as described in NFPA 13 and as detailed in this bulletin.

In addition, the Model KFR-CCS sprinkler is specifically listed for the protection of horizontal combustible concealed spaces with wood truss and bar joist construction up to and including 60" (900 mm) deep.

### Installation

Model KFR-CCS Sprinklers are to be installed in the upright position with their frame arms parallel to the pipe. When installing the Model KFR-CCS sprinkler use only the Reliable Model W2 installation wrench. Usage of any other type of installation wrench may damage the sprinkler and will void the manufacturer's warranty. Damaged sprinklers must be immediately replaced. A leak tight ½" NPT (R1/2) sprinkler joint can be obtained with an installation torque of approximately 8 -18 ft-lbs (10.8 – 24.4 N-m) after application of an appropriate thread sealant. Do not tighten sprinklers over these recommended limits. Doing so may cause leakage and/or premature operation.



Model W2 Wrench



### Maintenance

Reliable Model KFR-CCS series sprinklers should be inspected and the sprinkler system maintained in accordance with NFPA 25, as well as the requirements of any Authorities Having Jurisdiction. Prior to installation, sprinklers should remain in the original cartons and packaging until used. This will minimize the potential for damage to sprinklers that could cause improper operation or non-operation.

Do not clean sprinklers with soap and water, ammonia liquid or any other cleaning fluids. Remove dust by gentle vacuuming without touching the sprinkler.

Replace any sprinkler which has been painted (other than factory applied). A stock of spare sprinklers should be maintained to allow quick replacement of damaged or operated sprinklers. Failure to properly maintain sprinklers may result in inadvertent operation or non-operation during a fire event.

### Guarantee

For Reliable Automatic Sprinkler Co., Inc. guarantee, terms, and conditions, visit [www.reliablesprinkler.com](http://www.reliablesprinkler.com).

### Ordering Information

Specify: Model KFR-CCS Sprinkler  
W2 Wrench

**Model KFR-CCS Combustible Concealed Space Upright Sprinkler****SIN RA4454****Technical Specifications**

**Style:** Upright  
**Threads:** 1/2" NPT or ISO7-1R1/2  
**Nominal K-Factor:** 5.6 (80 metric)  
**Max. Working Pressure:** 175 psi (12 bar)

**Finish**

Standard Brass

**Temperature Ratings**

212°F (100°C)

**Sensitivity**

Fast Response

**Sprinkler Wrench**

Model W2

**Approvals**

cULus Listed

**Material Specifications**

**Thermal Sensor:** Nickel Alloy  
**Sprinkler Frame:** Brass Alloy  
**Button:** Copper Alloy  
**Sealing Assembly:** Nickel Alloy with PTFE  
**Load Screw:** Bronze Alloy  
**Deflector:** Bronze Alloy

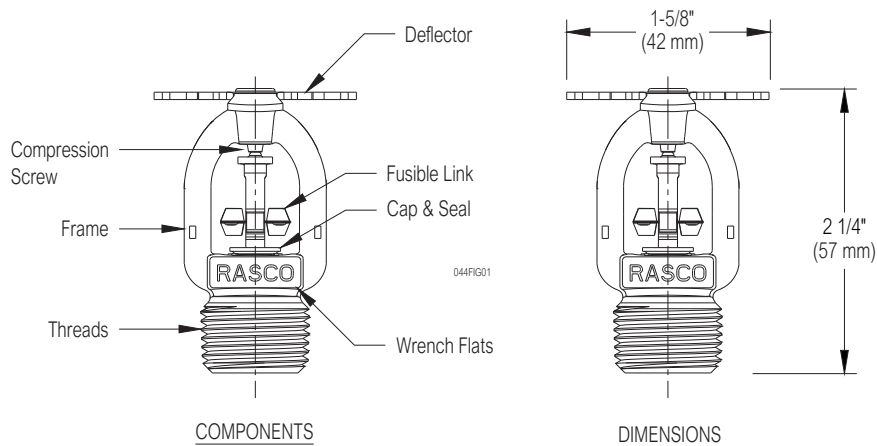
**Model KFR-CCS Components and Installation Dimensions****Figure 1****Model KFR-CCS General Application Criteria**

**Minimum Distance (Spacing) Between Sprinklers:** 6 ft (1.83 m)

**Note:** The minimum distance does not apply to any additional sprinklers that are required for protection of CPVC piping that is offset over an obstruction.

**Maximum Distance (Spacing) Between Sprinklers:** (Refer to Figures 2 through 7)

**Maximum Coverage Area Per Sprinkler:** (Refer to Figures 2 through 7)

**Deflector Distance:** (Refer to Figures 2 through 7)

**Minimum Distance Away From Face of Wood Truss or Top Chord of Bar Joist:** 4-1/2 in. (114 mm)

**Obstruction Rules:**

1. Sprinklers may not be installed such that the deflector is above the bottom of the top chord of trusses or joists.
2. Gusset plates, truss members, or bar joist members (other than top chords) shall not be considered obstructions provided a minimum 4-1/2 in. (114 mm) lateral distance from the edge of the member to the centerline of the sprinkler (required by the specific application listing) is maintained.
3. Where the Model KFR-CCS sprinkler is spaced over 225 ft<sup>2</sup> (20.9 m<sup>2</sup>), apply the obstruction rules found in NFPA 13 for extended coverage sprinklers, except as noted in #2 above.
4. Where the Model KFR-CCS sprinkler is spaced 225 ft<sup>2</sup> (20.9 m<sup>2</sup>) or less, apply the obstruction rules found in NFPA 13 for standard spray sprinklers, except as noted in #2 above.

## Application Criteria for Unobstructed Wood Truss Construction

The Model KFR-CCS Sprinkler is specifically listed to provide protection of combustible concealed spaces where (a) the construction method consists of wood trusses or bar joists with top chord depth not exceeding 4 in. (100 mm), (b) the maximum depth of the space is 60 in. (1.5 m) as measured from bottom of deck to top of ceiling, and (c) the slope of the upper deck does not exceed 2 in 12. (See Figures 2 and 3).

## Application Criteria for Obstructed Wood Truss Construction

The Model KFR-CCS Sprinkler is specifically listed to provide protection of combustible concealed spaces where (a) the construction method consists of wood trusses or bar joists with top chord depth exceeding 4 in. (100 mm), (b) the maximum depth of the space is 60 in. (1.5 m) as measured from bottom of deck to top of ceiling, and (c) the slope of the upper deck does not exceed 2 in 12. (See Figure 4).

## Application Criteria for Solid or Composite Wood Joist Construction

The Model KFR-CCS Sprinkler is specifically listed to provide protection of combustible concealed spaces where (a) the construction method consists of solid or composite wood joists, (b) the depth of the space does not exceed 36 in. (900 mm) as measured from the bottom of the upper joist to top of the bottom joist (or ceiling if joists are not present), and (c) the slope of the upper deck does not exceed 2 in 12. (See Figures 5, 6, and 7).

## Special Requirements When Using CPVC Materials

Unless modified by this technical bulletin, all guidelines provided by the CPVC pipe and fitting manufacturer must be followed.

When using CPVC pipe and fittings, the bottom of horizontal runs of pipe must be a maximum of 6 in. (150 mm) above the ceiling or noncombustible ceiling insulation, or 1/3 the depth of concealed space (as measured from the top surface of the ceiling to the bottom of the deck above), whichever is smaller.

Where the members at the bottom of the concealed space are greater than 6 in. (150 mm) tall, installing CPVC piping directly on top of those members shall be permitted.

When using 1 in. (DN25) or larger pipe, a hanger must be located at the truss nearest a sprig for purposes of restraint. If using 3/4 in. (DN19) piping, all sprigs over 12 in. (300 mm) must be laterally braced using methods described in the NFPA standards.

Where CPVC pipe must be offset up and over an obstruction, the CPVC pipe must be kept within 6 in. of the obstruction and additional Model KFR-CCS Sprinklers are to be installed to protect the CPVC material.

A minimum lateral distance of 18 in. (460 mm) must be maintained between the CPVC pipe and heat pumps, fan motors, and heat lamps.

CPVC piping can be used to supply the Model KFR-CCS Sprinklers as well as sprinklers installed below the ceiling.

CPVC risers passing through the horizontal combustible concealed space must be protected using one of the three options shown in Figure 8.

## Draft Curtain Requirements

Where provided or required, draft curtains shall be at least 1/3 the depth of the concealed space or 8 in. (200 mm), whichever is greater, and shall be constructed using minimum 1/4 in. plywood or other material that will not allow heat to escape through or pass above the draft curtain. Full height walls are acceptable substitutes for draft curtains.

## General Hydraulic Design Requirements

System Types:	Wet (CPVC or Steel Pipe); Dry or Preaction (Steel Pipe only)
Design Method:	Density/Area per NFPA 13, except as modified herein
Hazard Classification:	Light Hazard
Minimum Density:	0.10 gpm/ft <sup>2</sup> (4.1 Lpm/m <sup>2</sup> )
Minimum Operating Pressure:	7 psi (0.48 bar)
Design Area:	(Reference Figures 2 through 7)

Draft Curtains: Not Required (See Hydraulic Design notes below)

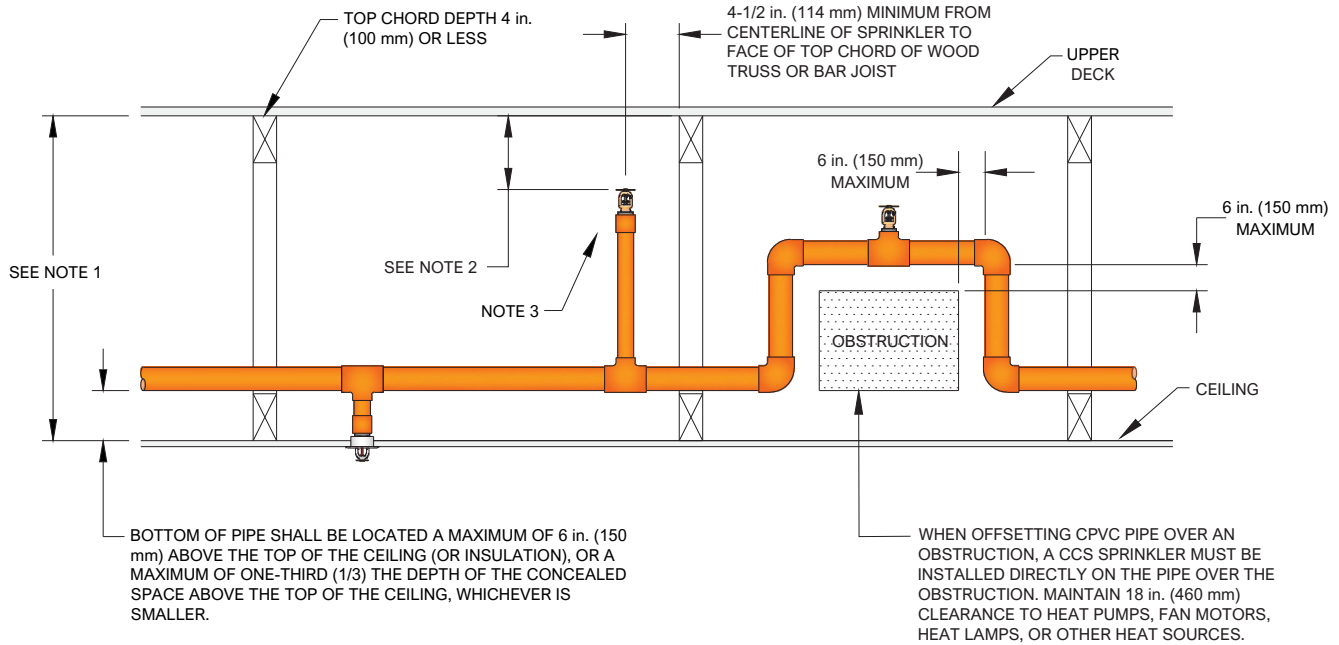

INSTALLATION NOTES:

1. DISTANCE EVALUATED AS PART OF THE cULus LISTING: 12 in. TO 60 in. (300 mm TO 1500 mm). NFPA 13 PERMITS INSTALLATION OF THE SPRINKLER WHERE THIS DISTANCE IS LESS THAN 12 in. (300 mm).
2. DEFLECTOR DISTANCE TO BE NO LESS THAN 1-1/2 in. (38 mm) AND NO MORE THAN 4 in. (100 mm) BELOW BOTTOM OF THE ROOF DECK. IN NO CASE SHALL DEFLECTOR BE ABOVE THE BOTTOM OF THE TOP CHORD.
3. INSTALL SPRINKLER WITH FRAME ARMS PARALLEL TO PIPE.

SPRINKLER SPACING AND COVERAGE AREA

- A. 16 ft (4.9 m) MAXIMUM BETWEEN SPRINKLERS
- B. 6 ft (1.8 m) MINIMUM BETWEEN SPRINKLERS (DOES NOT APPLY TO SPRINKLERS ADDED TO PROTECT CPVC PIPING OFFSET OVER AN OBSTRUCTION)
- C. 256 ft<sup>2</sup> (23.8 m<sup>2</sup>) MAXIMUM COVERAGE AREA PER SPRINKLER

HYDRAULIC DESIGN AREA REQUIREMENTS

- A. WET SYSTEM: WHERE DRAFT CURTAINS (OR FULL HEIGHT WALLS) ARE PROVIDED AT MAXIMUM AREAS OF 1000 ft<sup>2</sup> (93 m<sup>2</sup>) OR LESS, CALCULATE ALL SPRINKLERS WITHIN THE COMPARTMENTED AREA.
- B. WET SYSTEM: WHERE DRAFT CURTAINS (OR FULL HEIGHT WALLS) ARE NOT PROVIDED, OR PROVIDED AT AREAS EXCEEDING 1000 ft<sup>2</sup> (93 m<sup>2</sup>), CALCULATE AN AREA OF 1000 ft<sup>2</sup> (93 m<sup>2</sup>) OR SIX SPRINKLERS, WHICHEVER CREATES THE GREATER DEMAND.
- C. ADDITIONAL SPRINKLERS THAT ARE REQUIRED FOR PROTECTION OF CPVC PIPING THAT IS OFFSET OVER AN OBSTRUCTION DO NOT NEED TO BE INCLUDED IN THE DESIGN AREA.

Draft Curtains: Not Required (See Hydraulic Design notes below)

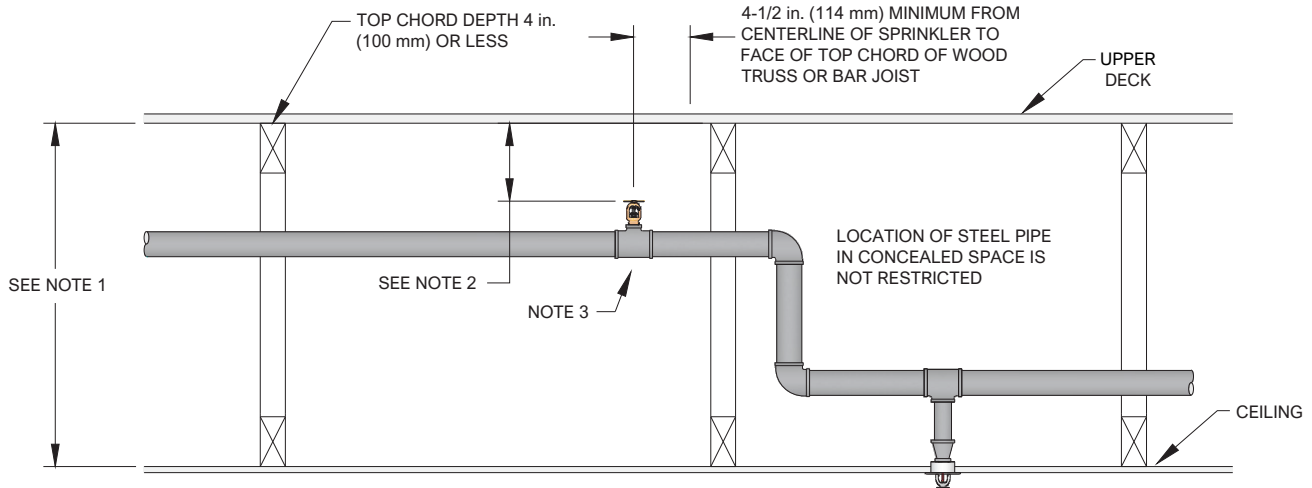

INSTALLATION NOTES:

1. DISTANCE EVALUATED AS PART OF THE cULus LISTING: 12 in. TO 60 in. (300 mm TO 900 mm). NFPA 13 PERMITS INSTALLATION OF THE SPRINKLER WHERE THIS DISTANCE IS LESS THAN 12 in. (300 mm).
2. DEFLECTOR DISTANCE TO BE NO LESS THAN 1-1/2 in. (38 mm) AND NO MORE THAN 4 in. (100 mm) BELOW THE BOTTOM OF THE ROOF DECK. IN NO CASE SHALL DEFLECTOR BE ABOVE THE BOTTOM OF THE TOP CHORD.
3. INSTALL SPRINKLER WITH FRAME ARMS PARALLEL TO PIPE.

SPRINKLER SPACING AND COVERAGE AREA

- A. 16 ft (4.9 m) MAXIMUM BETWEEN SPRINKLERS
- B. 6 ft (1.8 m) MINIMUM BETWEEN SPRINKLERS
- C. 256 ft<sup>2</sup> (23.8 m<sup>2</sup>) MAXIMUM COVERAGE AREA PER SPRINKLER

HYDRAULIC DESIGN AREA REQUIREMENTS

1. WET OR DRY SYSTEM: WHERE DRAFT CURTAINS (OR FULL HEIGHT WALLS) ARE PROVIDED AT MAXIMUM AREAS OF 1000 ft<sup>2</sup> (93 m<sup>2</sup>) OR LESS, CALCULATE ALL SPRINKLERS WITHIN THE COMPARTMENTED AREA.
2. WET SYSTEM: WHERE DRAFT CURTAINS OR FULL HEIGHT WALLS ARE NOT PROVIDED, OR PROVIDED AT AREAS EXCEEDING 1000 ft<sup>2</sup> (93 m<sup>2</sup>), CALCULATE AN AREA OF 1000 ft<sup>2</sup> (93 m<sup>2</sup>) OR SIX SPRINKLERS, WHICHEVER CREATES THE GREATER DEMAND.
3. DRY SYSTEM: WHERE DRAFT CURTAINS OR FULL HEIGHT WALLS ARE NOT PROVIDED, OR PROVIDED AT AREAS EXCEEDING 1000 ft<sup>2</sup> (93 m<sup>2</sup>), CALCULATE AN AREA OF 1000 ft<sup>2</sup> (93 m<sup>2</sup>) OR NINE SPRINKLERS, WHICHEVER CREATES THE GREATER DEMAND.

### Draft Curtain and Blocking: Required at 1000 ft<sup>2</sup> (93 m<sup>2</sup>)

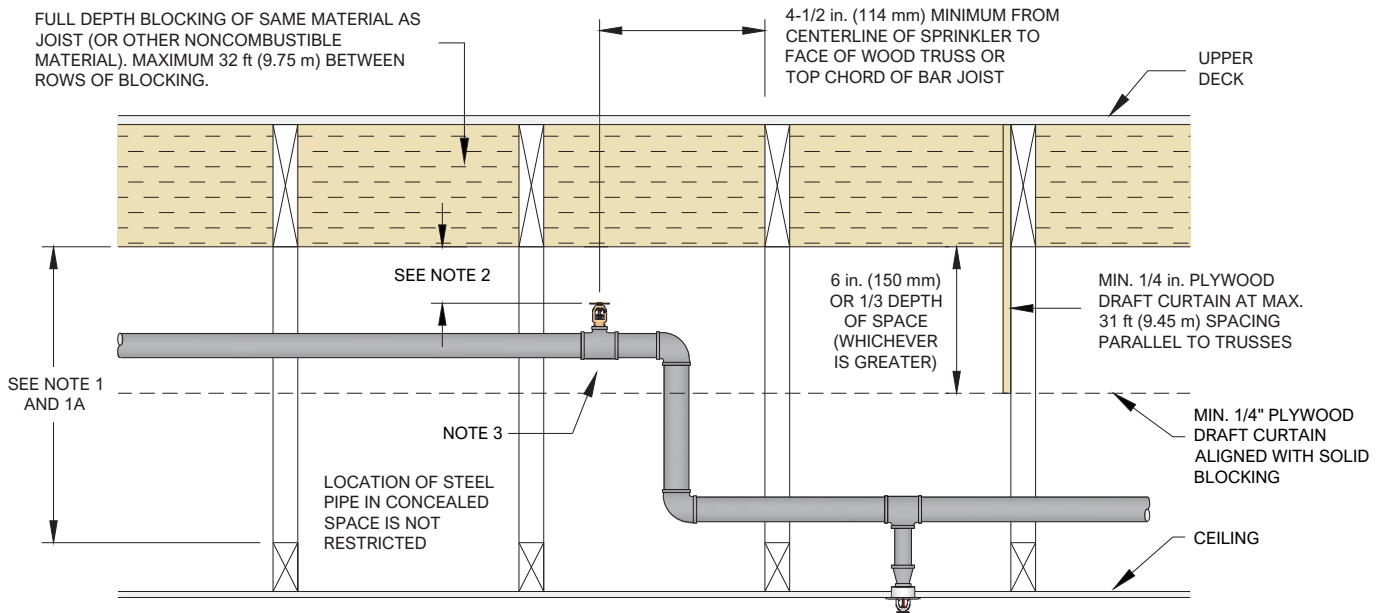

**INSTALLATION NOTES:**

1. DISTANCE EVALUATED AS PART OF THE cULus LISTING: 12 in. TO 60 in. (300 mm TO 1500 mm). NFPA 13 PERMITS INSTALLATION OF THE SPRINKLER WHERE THIS DISTANCE IS LESS THAN 12 in. (300 mm).
- 1A. WHERE CEILING IS NOT SUPPORTED BY JOISTS (EXAMPLE: SUSPENDED A.C.T.) MEASUREMENT POINT IS TOP OF CEILING.
2. DEFLECTOR DISTANCE BELOW BOTTOM OF JOIST TO BE 1-1/2 in. TO 2 in. (38 mm TO 50 mm). IN NO CASE SHALL DEFLECTOR BE ABOVE THE BOTTOM OF THE JOIST.
3. INSTALL SPRINKLER WITH FRAME ARMS PARALLEL TO PIPE.

**SPRINKLER SPACING AND COVERAGE AREA**

- A. 14 ft (4.3 m) MAXIMUM BETWEEN SPRINKLERS
- B. 6 ft (1.8 m) MINIMUM BETWEEN SPRINKLERS
- C. 196 ft<sup>2</sup> (18.2 m<sup>2</sup>) MAXIMUM COVERAGE AREA PER SPRINKLER

**HYDRAULIC DESIGN AREA REQUIREMENTS**

1. WET OR DRY SYSTEM: BLOCKING AND DRAFT CURTAINS (OR FULL HEIGHT WALLS) MUST BE PROVIDED AT 1000 ft<sup>2</sup> (93 m<sup>2</sup>) MAXIMUM AREAS. CALCULATE ALL SPRINKLERS WITHIN THE COMPARTMENTED AREA.

### Draft Curtains: Required at 1000 ft<sup>2</sup> (93 m<sup>2</sup>)

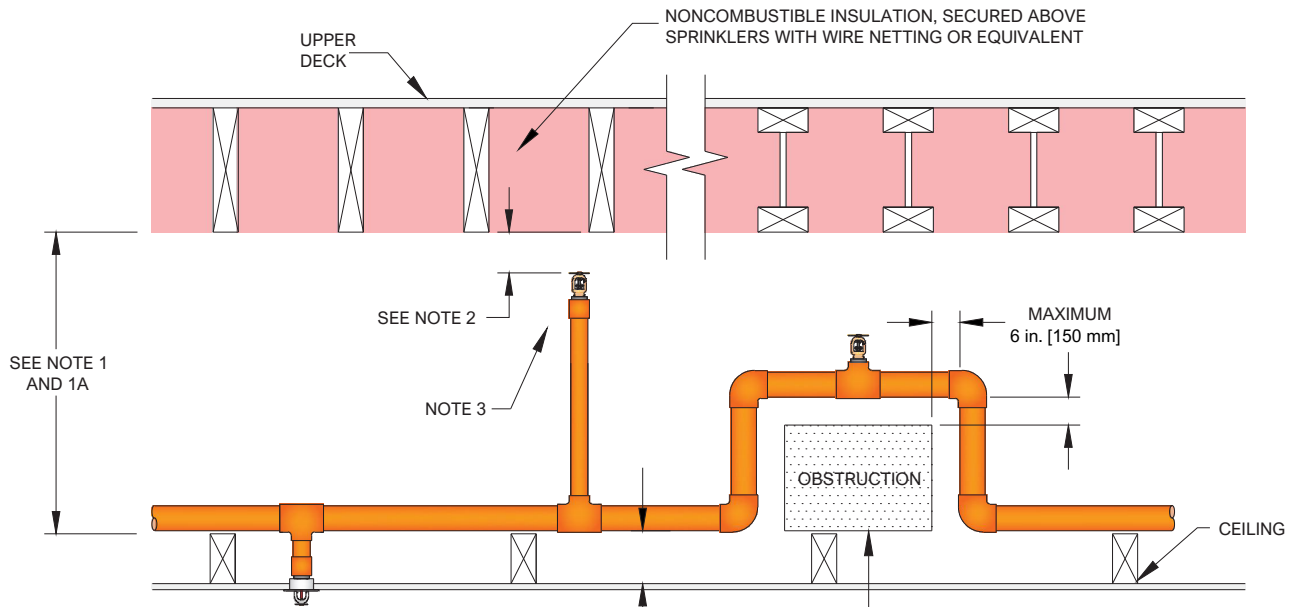

BOTTOM OF PIPE SHALL BE LOCATED A MAXIMUM OF 6 in. (150 mm) ABOVE THE TOP OF THE CEILING (OR INSULATION), OR A MAXIMUM OF ONE-THIRD (1/3) THE DEPTH OF THE CONCEALED SPACE ABOVE THE TOP OF THE CEILING, WHICHEVER IS SMALLER.

WHEN OFFSETTING CPVC PIPE OVER OBSTRUCTION, A CCS SPRINKLER MUST BE INSTALLED DIRECTLY ON THE PIPE OVER THE OBSTRUCTION.

**INSTALLATION NOTES:**

1. DISTANCE EVALUATED AS PART OF THE cULus LISTING: 12 in. TO 36 in. (300 mm TO 900 mm). NFPA 13 PERMITS INSTALLATION OF THE SPRINKLER WHERE THIS DISTANCE IS LESS THAN 12 in. (300 mm).
- 1A. WHERE CEILING IS NOT SUPPORTED BY JOISTS (EXAMPLE: SUSPENDED A.C.T.) MEASUREMENT POINT IS TOP OF CEILING.
2. DEFLECTOR DISTANCE BELOW BOTTOM OF JOIST TO BE 1-1/2 in. TO 4 in. (38 mm TO 100 mm). IN NO CASE SHALL DEFLECTOR BE ABOVE THE BOTTOM OF THE SOLID OR COMPOSITE WOOD JOIST.
3. INSTALL SPRINKLER WITH FRAME ARMS PARALLEL TO PIPE.

**SPRINKLER SPACING AND COVERAGE AREA**

- A. 16 ft (4.9 m) MAXIMUM BETWEEN SPRINKLERS
- B. 6 ft (1.8 m) MINIMUM BETWEEN SPRINKLERS
- C. 256 ft<sup>2</sup> (23.4 m<sup>2</sup>) MAXIMUM COVERAGE AREA PER SPRINKLER

**HYDRAULIC DESIGN AREA REQUIREMENTS**

1. WET SYSTEM: DRAFT CURTAINS (OR FULL HEIGHT WALLS) MUST BE PROVIDED AT 1000 ft<sup>2</sup> (93 m<sup>2</sup>) MAXIMUM AREAS. CALCULATE ALL SPRINKLERS WITHIN THE COMPARTMENTED AREA.
2. ADDITIONAL SPRINKLERS THAT ARE REQUIRED FOR PROTECTION OF CPVC PIPING THAT IS OFFSET OVER AN OBSTRUCTION DO NOT NEED TO BE INCLUDED IN THE DESIGN AREA.

Draft Curtain and Blocking: Required at 1000 ft<sup>2</sup> (93 m<sup>2</sup>)

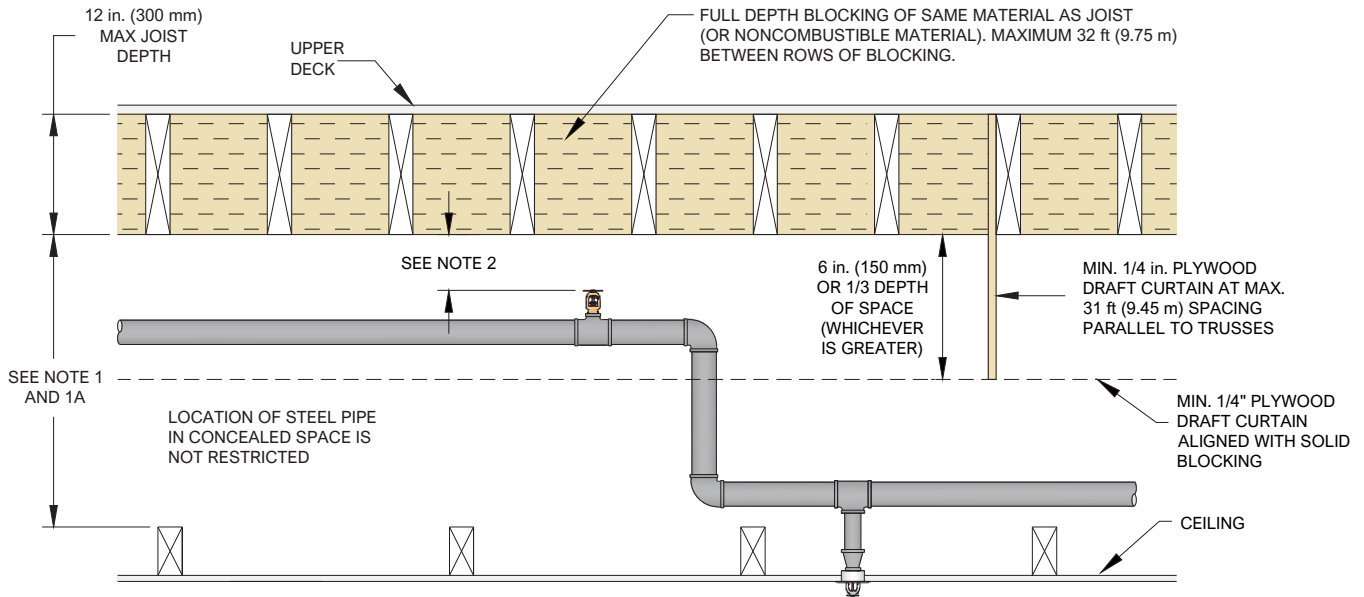

INSTALLATION NOTES:

1. DISTANCE EVALUATED AS PART OF THE cULus LISTING: 12 in. TO 36 in. (300 mm TO 900 mm). NFPA 13 PERMITS INSTALLATION OF THE SPRINKLER WHERE THIS DISTANCE IS LESS THAN 12 in. (300 mm).
- 1A. WHERE CEILING IS NOT SUPPORTED BY JOISTS (EXAMPLE: SUSPENDED A.C.T.) MEASUREMENT POINT IS TOP OF CEILING.
2. DEFLECTOR DISTANCE BELOW BOTTOM OF JOIST TO BE 1-1/2 in. TO 2 in. (38 mm TO 50 mm). IN NO CASE SHALL DEFLECTOR BE ABOVE THE BOTTOM OF THE SOLID OR COMPOSITE WOOD JOIST.
3. INSTALL SPRINKLER WITH FRAME ARMS PARALLEL TO PIPE.

SPRINKLER SPACING AND COVERAGE AREA

- A. 14 ft (4.3 m) MAXIMUM BETWEEN SPRINKLERS
- B. 6 ft (1.8 m) MINIMUM BETWEEN SPRINKLERS
- C. 196 ft<sup>2</sup> (18.2 m<sup>2</sup>) MAXIMUM COVERAGE AREA PER SPRINKLER

HYDRAULIC DESIGN AREA REQUIREMENTS

1. WET OR DRY SYSTEM: BLOCKING AND DRAFT CURTAINS (OR FULL HEIGHT WALLS) MUST BE PROVIDED AT 1000 ft<sup>2</sup> (93 m<sup>2</sup>) MAXIMUM AREAS. CALCULATE ALL SPRINKLERS WITHIN THE COMPARTMENTED AREA.



## Draft Curtain and Blocking: Not Required

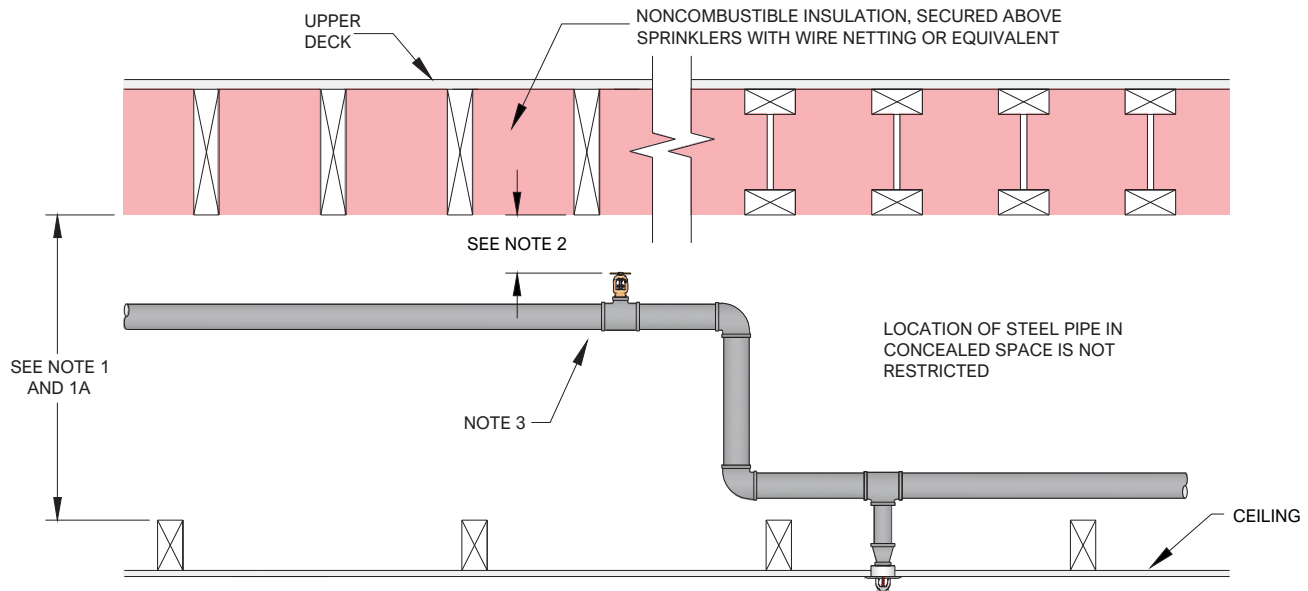

## INSTALLATION NOTES:

1. DISTANCE EVALUATED AS PART OF THE cULus LISTING: 12 in. TO 36 in. (300 mm TO 900 mm). NFPA 13 PERMITS INSTALLATION OF THE SPRINKLER WHERE THIS DISTANCE IS LESS THAN 12 in. (300 mm).
- 1A. WHERE CEILING IS NOT SUPPORTED BY JOISTS (EXAMPLE: SUSPENDED A.C.T.) MEASUREMENT POINT IS TOP OF CEILING.
2. DEFLECTOR DISTANCE BELOW BOTTOM OF JOIST TO BE 1-1/2 in. TO 4 in. (38 mm TO 100 mm). IN NO CASE SHALL DEFLECTOR BE ABOVE THE BOTTOM OF THE SOLID OR COMPOSITE WOOD JOIST.
3. INSTALL SPRINKLER WITH FRAME ARMS PARALLEL TO PIPE.

## SPRINKLER SPACING AND COVERAGE AREA

- A. 16 ft (4.9 m) MAXIMUM BETWEEN SPRINKLERS
- B. 6 ft (1.8 m) MINIMUM BETWEEN SPRINKLERS
- C. 256 ft<sup>2</sup> (23.4 m<sup>2</sup>) MAXIMUM COVERAGE AREA PER SPRINKLER

## HYDRAULIC DESIGN AREA REQUIREMENTS

1. WET OR DRY SYSTEM: BLOCKING AND DRAFT CURTAINS (OR FULL HEIGHT WALLS) ARE NOT REQUIRED. CALCULATE A MINIMUM HYDRAULIC DESIGN AREA OF 900 ft<sup>2</sup> (84 m<sup>2</sup>) OR 5 SPRINKLERS, WHICHEVER IS GREATER.

